

Building digital marketplaces

- Digital supply chain

Lars Chr. Fredenlund
CEO
Cobuilder

Madrid, 20th of June 2019

About coBuilder

- coBuilder is a Norwegian technology company with a European presence operating at the forefront of digitalizing the Construction Industry.
- The company is a privately owned medium-sized company based in Oslo, Norway. Operating in the market since 1997, coBuilder has positioned itself as a company having vast product data/information expertise within the AECO industry. The group companies have a total of 135 employees (Q1/19), 20 people on full time in Norway.
- Sales offices in the UK & France and exclusive distributors in Italy, Austria, Germany & Finland.
- Member of BuildingSMART International
- Winner of multiple innovation awards in the UK
- Contributor to major international standardisation bodies such as ISO, buildingSMART, CEN and CENELEC.
- Are leading the global work in CEN&ISO on standardisation of Data Templates



The digital marketplace for the construction industry !



Similar, digitalisation in the construction sector made it possible to use structured standard-based product information for both setting specific product requirements and identifying, specifying and purchasing construction products that meet those requirements.

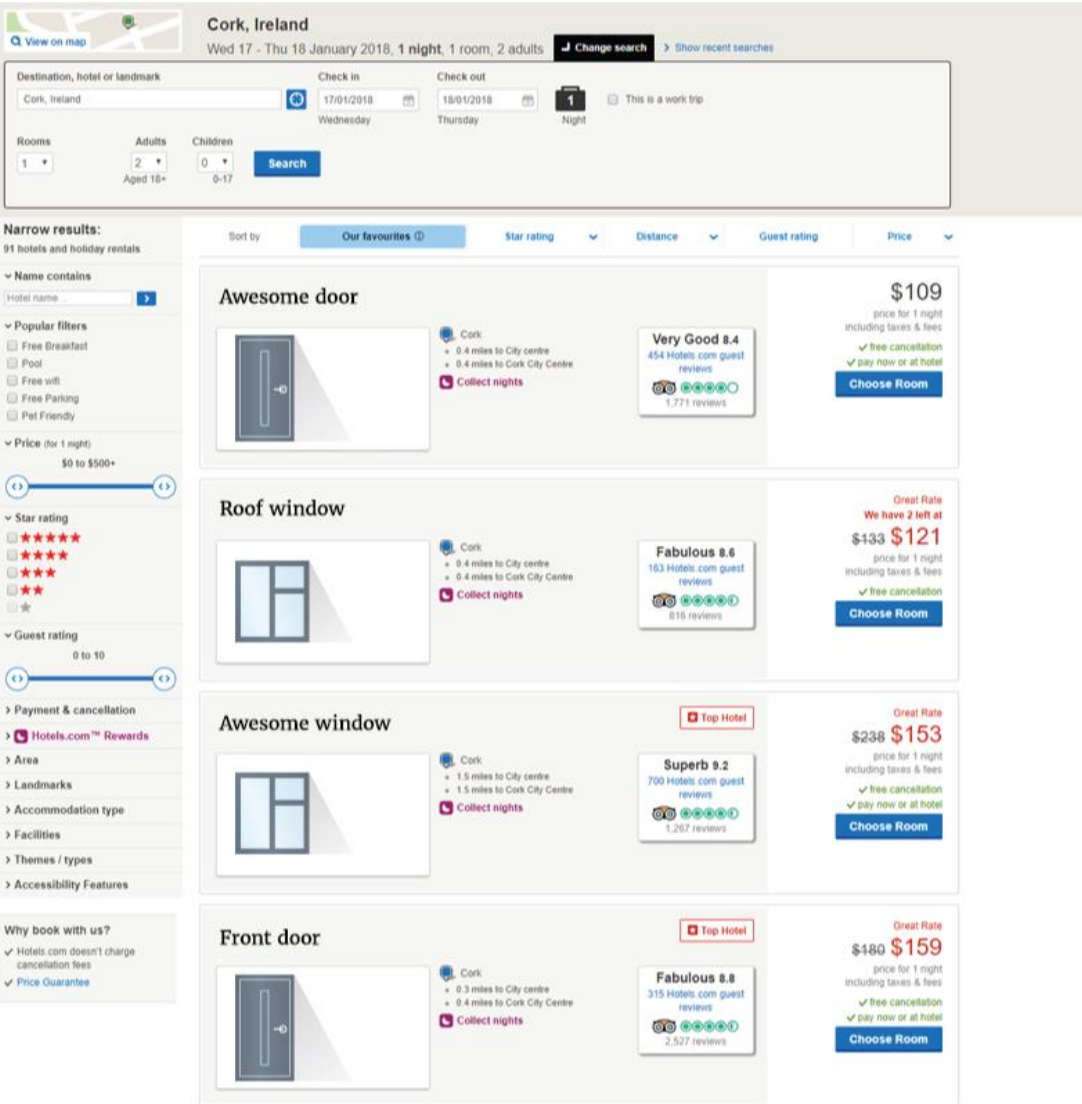

Cork, Ireland
Wed 17 - Thu 18 January 2018, 1 night, 1 room, 2 adults

Destination, hotel or landmark: Cork, Ireland
Check in: 17/01/2018
Check out: 18/01/2018
Rooms: 1
Adults: 2
Children: 0

Narrow results:
91 hotels and holiday rentals

- Name contains
- Popular filters: Free Breakfast, Pool, Free wifi, Free Parking, Pet Friendly
- Price (for 1 night): \$0 to \$500+
- Star rating: 5 stars, 4 stars, 3 stars, 2 stars, 1 star
- Guest rating: 0 to 10
- Payment & cancellation: Hotels.com™ Rewards
- Area
- Landmarks
- Accommodation type
- Facilities
- Themes / types
- Accessibility Features

Why book with us?
Hotels.com doesn't charge cancellation fees
Price Guarantee

Room Type	Price (per 1 night)	Guest Rating	Reviews
Awesome door	\$109	Very Good 8.4	1,771 reviews
Roof window	\$121	Fabulous 8.6	838 reviews
Awesome window	\$153	Superb 9.2	1,287 reviews
Front door	\$159	Fabulous 8.8	2,527 reviews

Twitter: @_fredenlund

The construction industry is among the least digitalized industry sectors

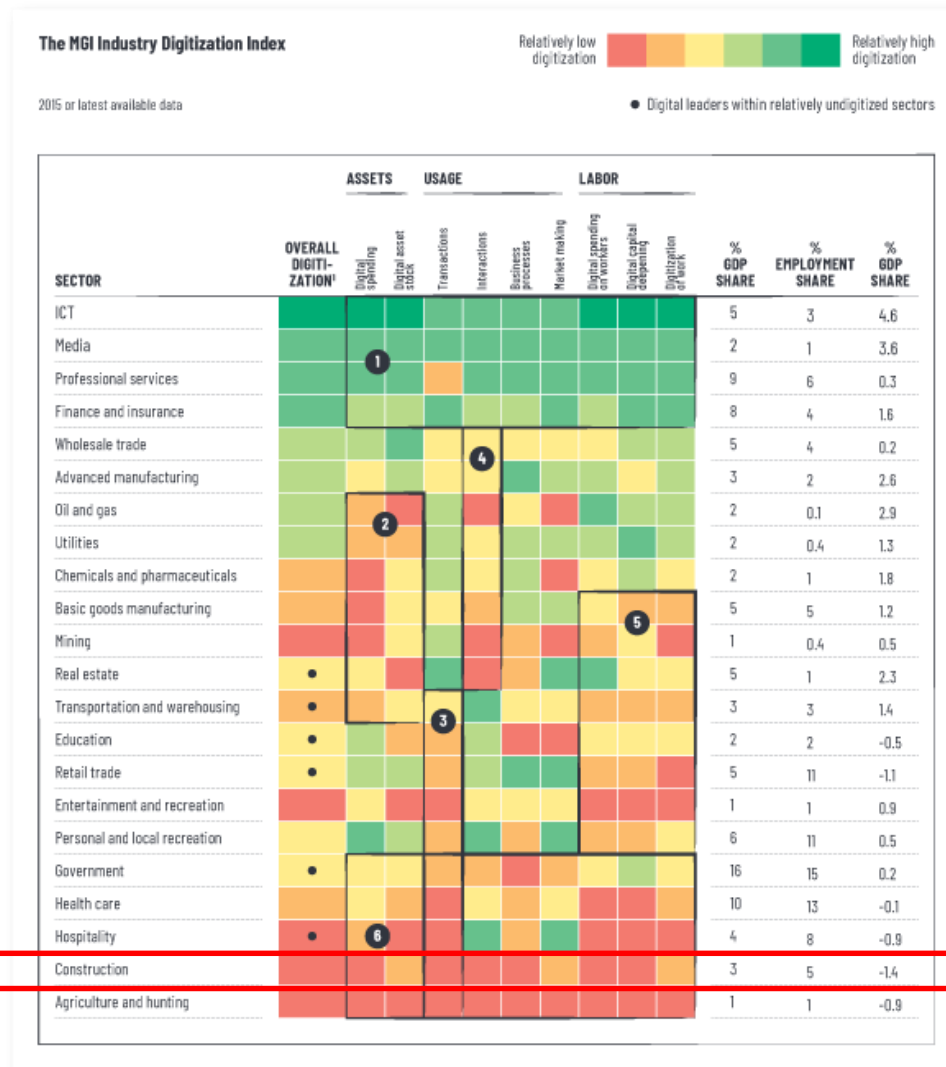

• Source: (left) McKinsey Global Institute analysis, 2015

Our common issues



**LOSS OF COMPETITIVE
ADVANTAGE**



**DELAYS IN GETTING YOUR
PRODUCT OR SERVICE
TO MARKET**



**INABILITY TO MEET
CUSTOMER EXPECTATIONS**



**DAMAGE TO REPUTATION
AND BRAND**



**INABILITY TO ATTRACT
AND RETAIN TALENT**



**FAILURE TO MEET
COMPLIANCE REQUIREMENTS**



**EXPOSURE TO
LEGAL ACTION**



**REDUCE CORPORATE
PROFITABILITY**



**DISRUPTION OF
BUSINESS OPERATIONS**



**IMPACT ON CASH FLOW
AND LIQUIDITY**

In most organizations “digital” is a subordinate area of either IT or marketing



Twitter: @_fredenlund

Digital twin - this new digital market is becoming a priority for market actors

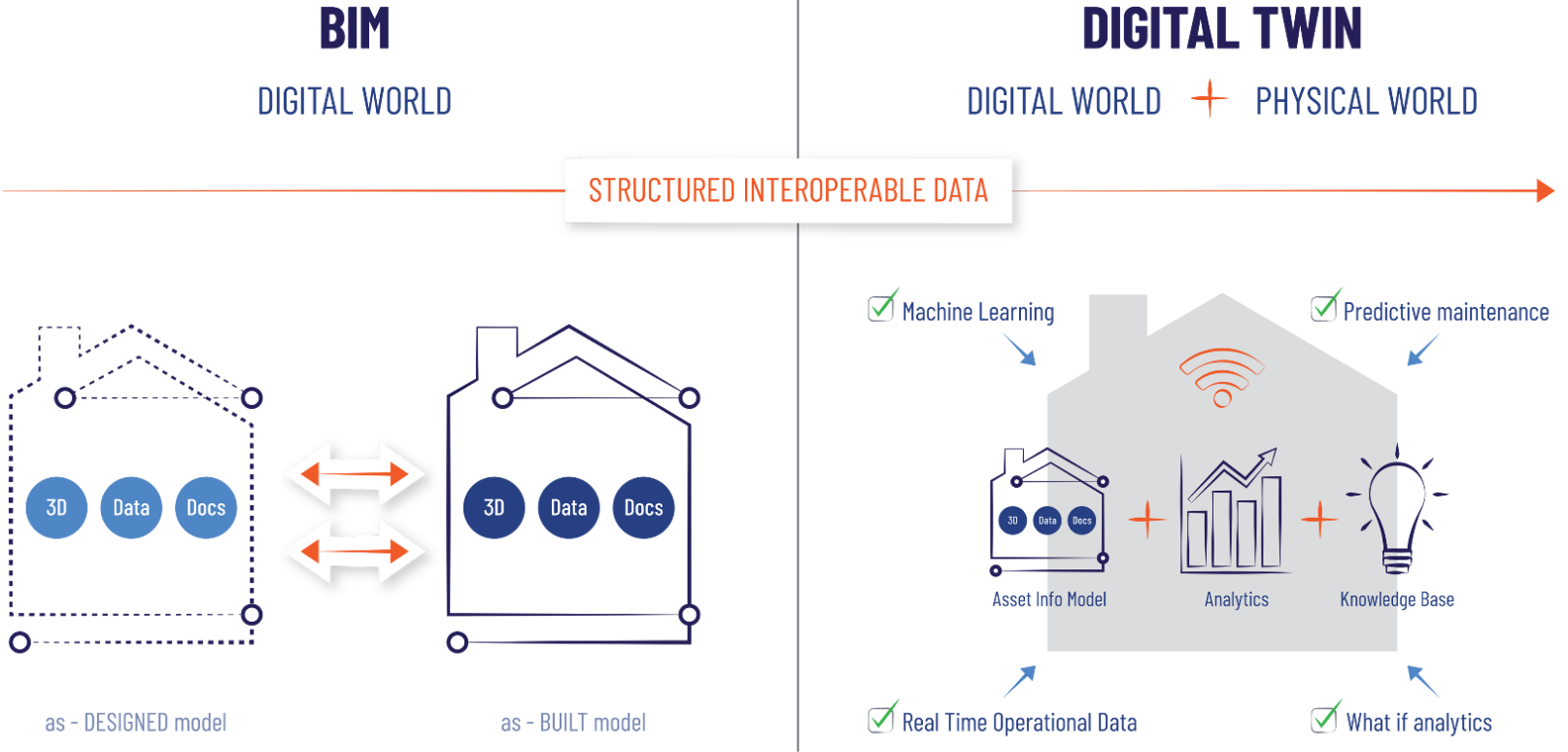

The as-designed model is based on input from the design teams which ultimately forms the basis for the as-built model that contains all the characteristics of a building. #CEN #ISO #ASTM etc. standards opens a closed market

BIM enables Cobuilder to provide data to create Digital Twins which is a virtual representation of physical as-built asset by linking standardized data to 3D. This opens a new digital market on planned development, where assets are sold

WARNING!! The fancy bit, BIM models = the Great Black Hole of BIM

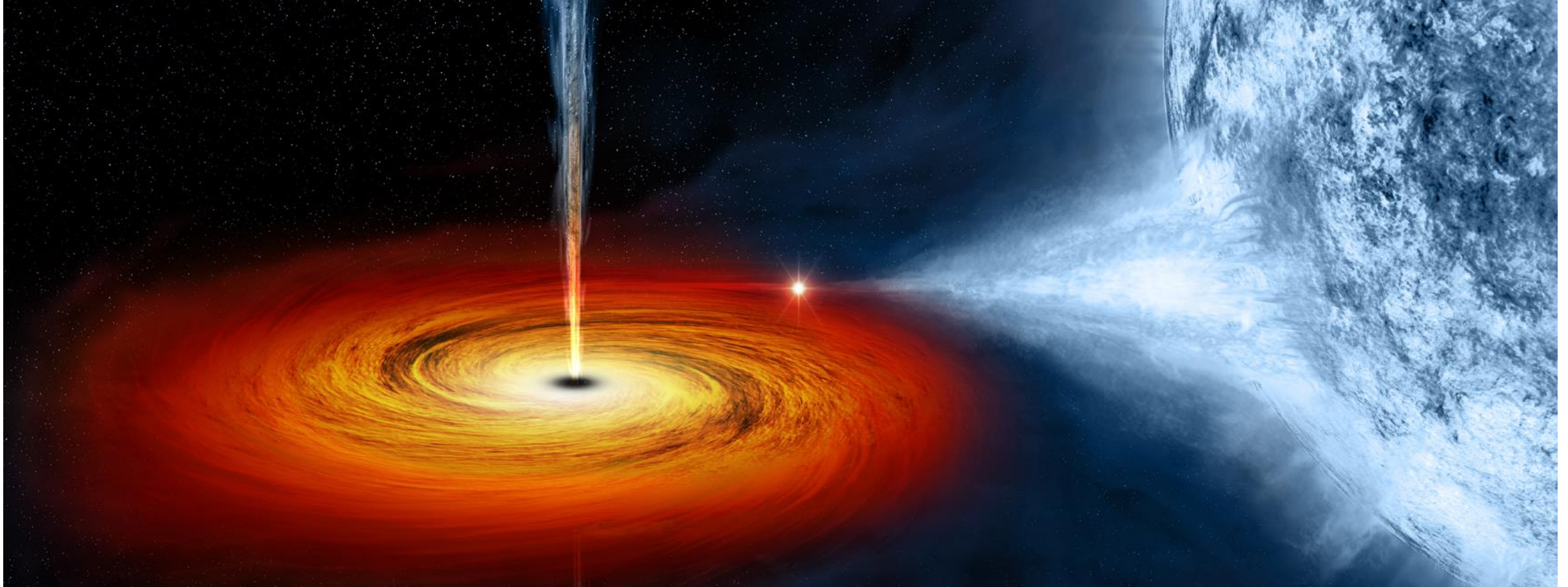

We need data - structured data !

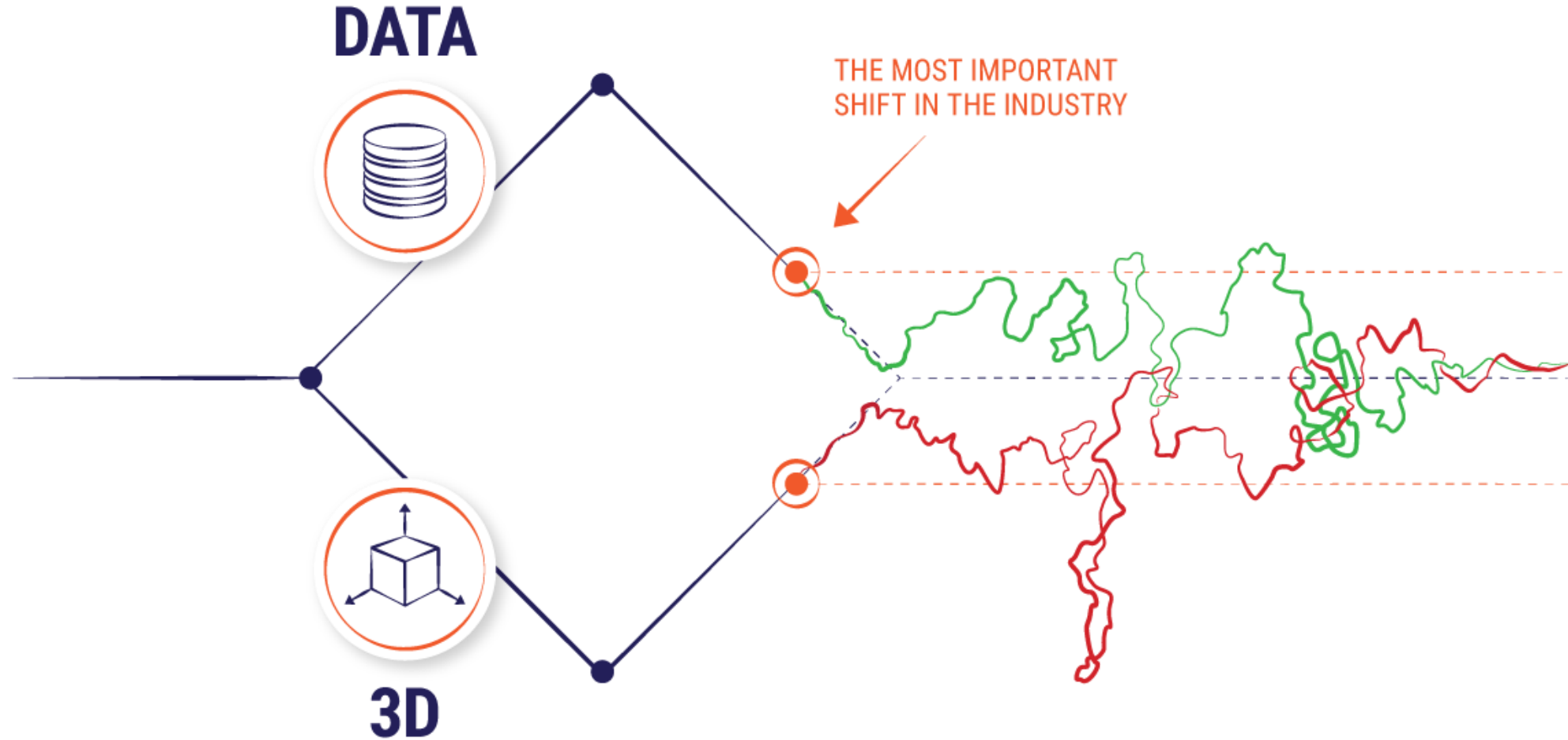

Twitter: @_fredenlund

The big issue: unstructured data

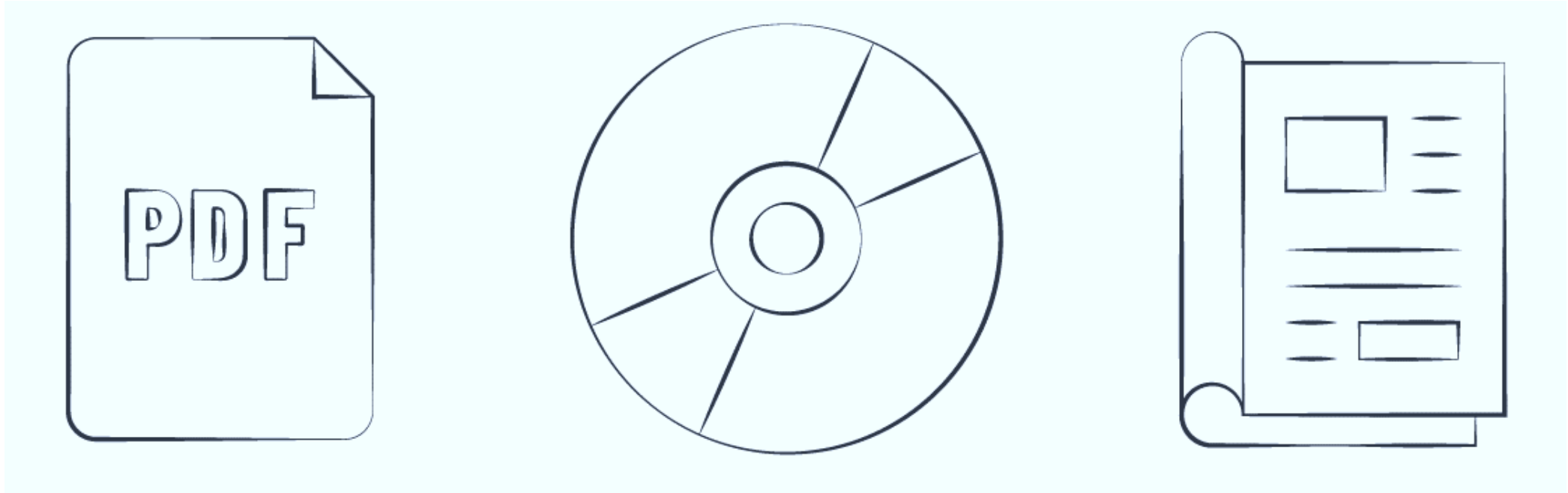

Twitter: @_fredenlund

Without standards?

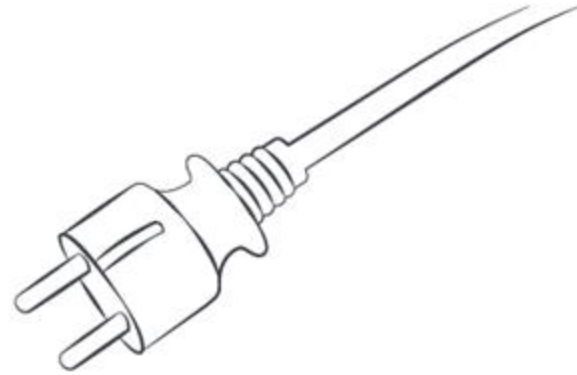
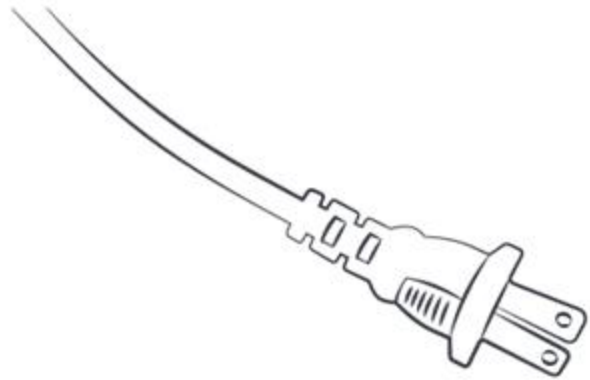

?

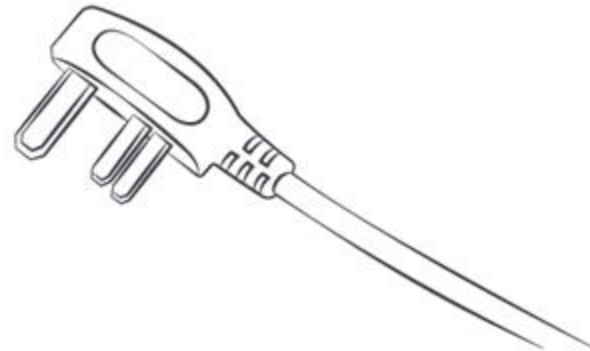
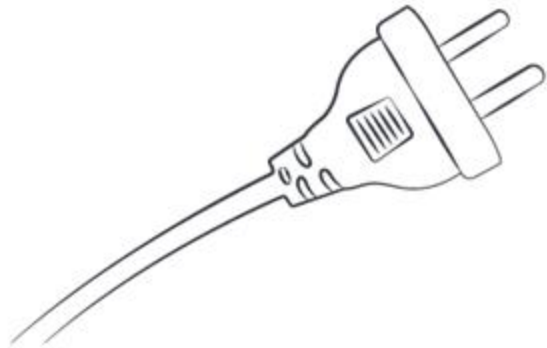

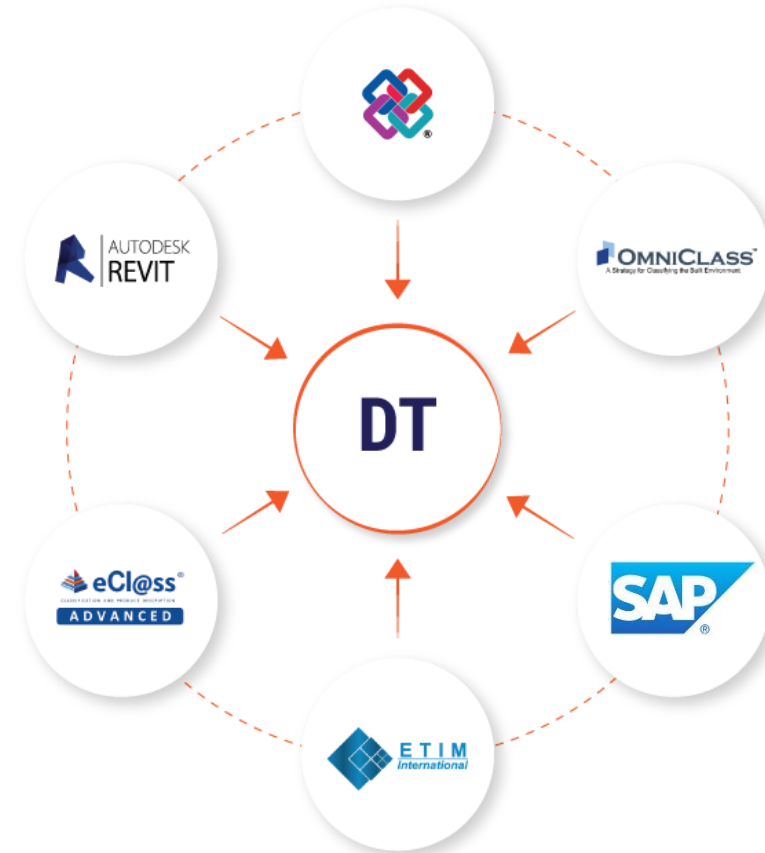

We have siloed data structures – works for all !

VS



Twitter: @_fredenlund

The solution - European standards for structuring Product Data



  

Support Data Dictionaries CEN/TC 442/WG 04
Date: 2016-08-29 Doc. Number: N 0019
Assistant: Your contact: Etienne CAILLEAU
Direct line: 01 41 62 85 71 etienne.cailleau@afnor.org

Expert process to describe, author and maintain properties

1

C...RIES / Dear Member,
D... Please find below a draft NWIP Product data templates based on CEN/CENELEC standards in an open European data dictionary - Part 1: General structure of a product data template and how to relate it to Industry Foundation Classes (IFC).
This draft NWIP is submitted by Norway ; it will be presented and discussed in Berlin before the official submission to CEN/TC 442.
Relations between the 4 NWIPs are explained in N-Document 21.
F...llowing on: 2016-09-13
S...URCE: CEN/TC 442/WG 4 Secretariat



  

Support Data Dictionaries CEN/TC 442/WG 04
Date: 2016-08-29 Doc. Number: N 0019
Assistant: Your contact: Etienne CAILLEAU
Direct line: 01 41 62 85 71 etienne.cailleau@afnor.org

Data templates for construction objects – Concepts and principles

2

C...RIES / Dear Member,
D... Please find below a draft NWIP Product data templates based on CEN/CENELEC standards in an open European data dictionary - Part 1: General structure of a product data template and how to relate it to Industry Foundation Classes (IFC).
This draft NWIP is submitted by Norway ; it will be presented and discussed in Berlin before the official submission to CEN/TC 442.
Relations between the 4 NWIPs are explained in N-Document 21.
F...llowing on: 2016-09-13
S...URCE: CEN/TC 442/WG 4 Secretariat

Support Data Dictionaries CEN/TC 442/WG 04
Date: 2016-08-29 Doc. Number: N 0020
Assistant: Your contact: Etienne CAILLEAU
Direct line: 01 41 62 85 71 etienne.cailleau@afnor.org

Data templates for construction objects – Data templates based on European product standards under CPR

3

C...RIES / Dear Member,
D... Please find below a draft NWIP Product data templates based on CEN/CENELEC standards in an open European data dictionary - Part 2: Framework for product data templates based on harmonised technical specifications under the Construction Products Regulation (CPR), and how to relate product data templates to Industry Foundation Classes (IFC).
This draft NWIP is submitted by Norway ; it will be presented and discussed in Berlin before the official submission to CEN/TC 442.
Relations between the 4 NWIPs are explained in N-Document 21.
F...llowing on: 2016-09-13
S...URCE: CEN/TC 442/WG 4 Secretariat

Standardised properties & Data Templates

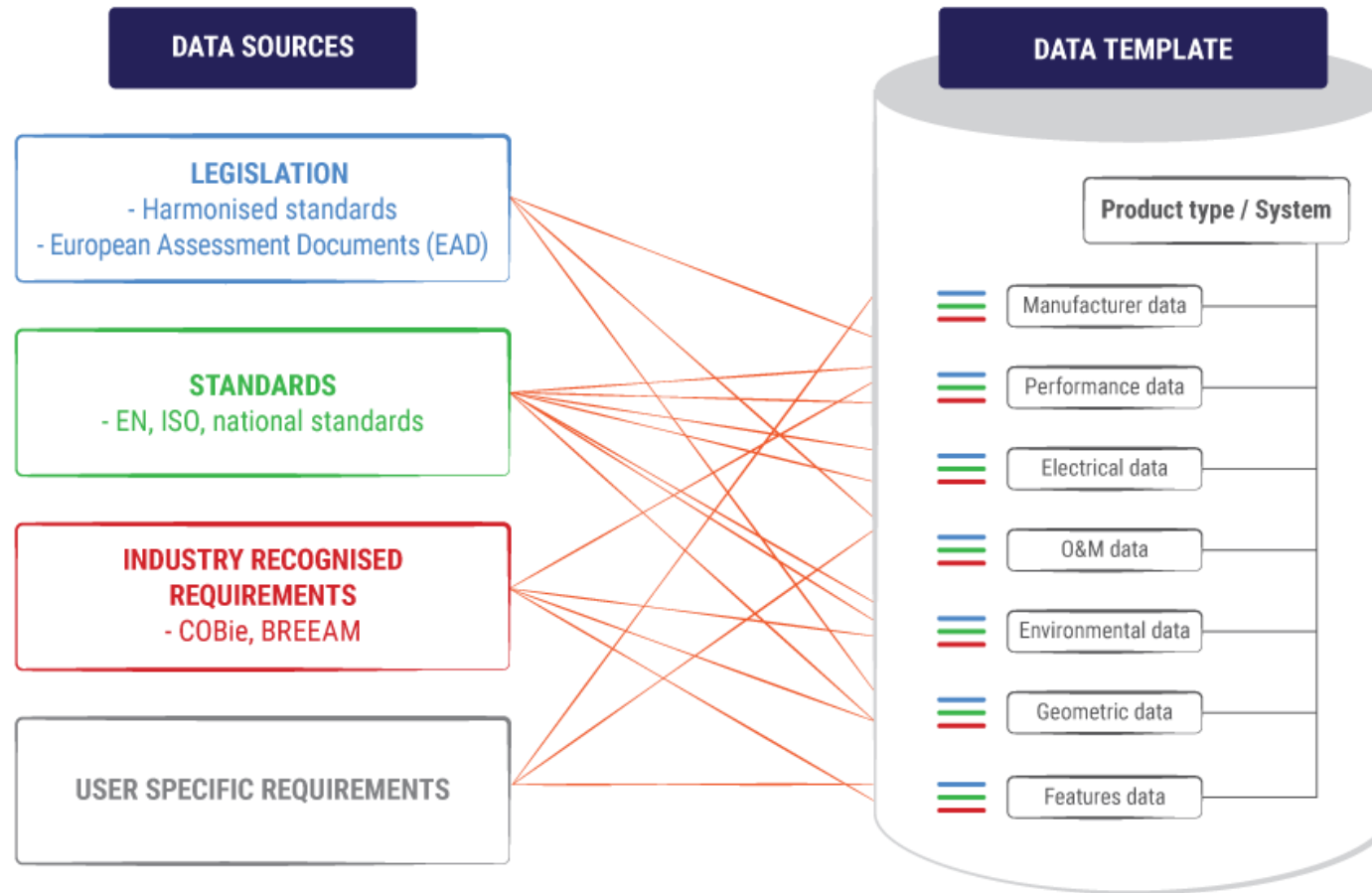

Data Templates - common language for the whole industry

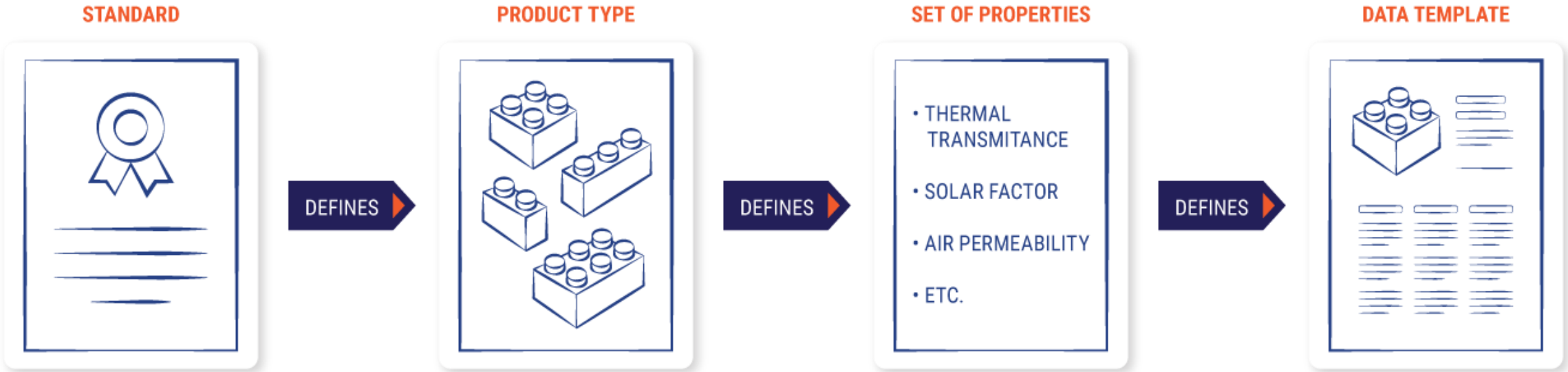

Standardisation at the local level = a common digital marketplace

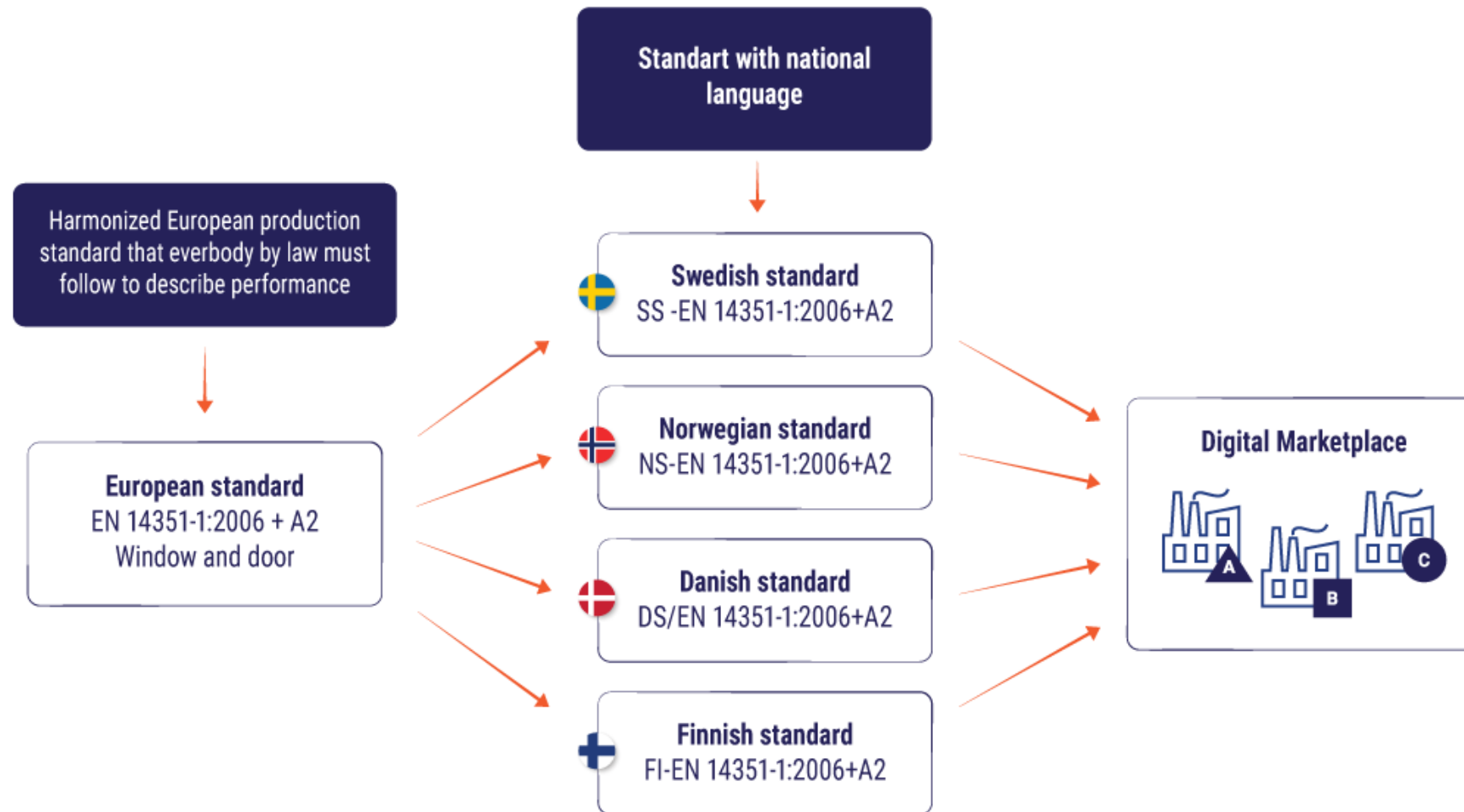

Data Templates – an example EN 14351 -1 (windows)

resistance to fire	resistance to fire according to EN 13501-2	assessment of the characteristic loadbearing capacity and/or integrity and/or insulation. also further optional characteristics, namely radiation, mechanical aspects, self-closing ability and smoke leakage	EI 15; EI 30; EI 45; EI 60; EI 90; EI 120; EI 180; EI 240
	undefined	duration for which a passive fire protection system can withstand a standard fire resistance test	
air permeability	air permeability class according to EN 1026	amount of air passing through a closed and fastened test specimen caused by the test pressure	class 0; class 1; class 2; class 3; class 4
	undefined	measure of how well air passes through an object	
weight	undefined	weight	
resistance to wind load	resistance to wind load class according to EN 12211	the wind resistance is characterized by the ability to withstand specified loads simulating the action of wind in positive or negative pressure without excessive frontal deflection	class 0; class 1; class 2; class 3; class 4; class 5;
	relative frontal deflection class according to EN 12211	frontal deflection of a frame member divided by the length of the member over which the frontal deflection was measured	class A; class B; class C
	undefined	the intensity of the pressure of the wind load over a construction	
impact resistance	drop height according to EN 13049	describes the height from which the impactor for the impact resistance test is dropped	200; 300; 450; 700; 950
	undefined	the characteristic of resistance to a force applied over a short period of time	

The golden thread – structured Data Templates

TEMPLATE

COBUILDER Window Template

CLASSIFICATION:

COBUILDER - Window
Uniclass 2 - Ss_25_30_95

Pset 1

- Assessment date
- Assessment condition
- Article number

Pset 2

- Type designator
- Special instructions
- Construction method
- Lifting strenght
- Point of contact

Pset 3

- Environmental impact indicators

REQUIREMENT

Window Type 1

CLASSIFICATION:

COBUILDER - Window
Uniclass 2 - Ss_25_30_95

Pset 1

- Assessment date ✓
- Assessment condition ✓
- Article number ✓

Pset 2

- Type designator
- Special instructions ✓
- Construction method
- Lifting strenght ✓
- Point of contact

Pset 3

- Environmental impact indicators

SPECIFICATION

Window Type 2

CLASSIFICATION:

COBUILDER - Window
Uniclass 2 - Ss_25_30_95

Pset 1

- Assessment date ≥ 01.01.2017
- Assessment condition
- Article number = 380585813

Pset 2

- Type designator
- Special instructions
- Construction method = Fixed window
- Lifting strenght ≥ 5
- Point of contact

Pset 3

- Environmental impact indicators

MANUFACTURED PRODUCT

Veka matrix 70

CLASSIFICATION:

COBUILDER - Window
Uniclass 2 - Ss_25_30_95

Pset 1

- Assessment date = 01.06.2017
- Assessment condition = hEN 15694
- Article number = 380585813

Pset 2

- Type designator = BGH08
- Special instructions = External use only
- Construction method = Fixed window
- Lifting strenght = 7
- Point of contact

Pset 3

- Environmental impact indicators

Data Templates – the new purchasing route

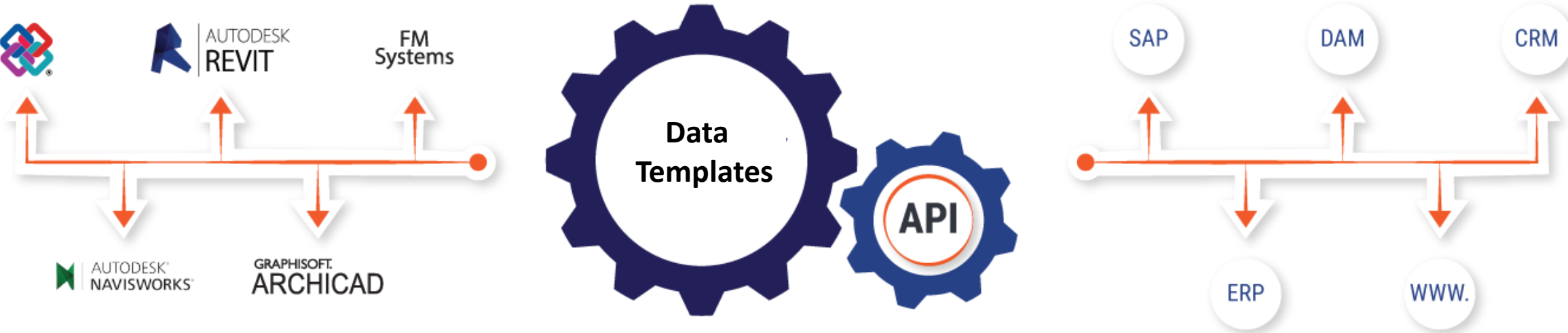

We also need GS1 standards, common identifiers

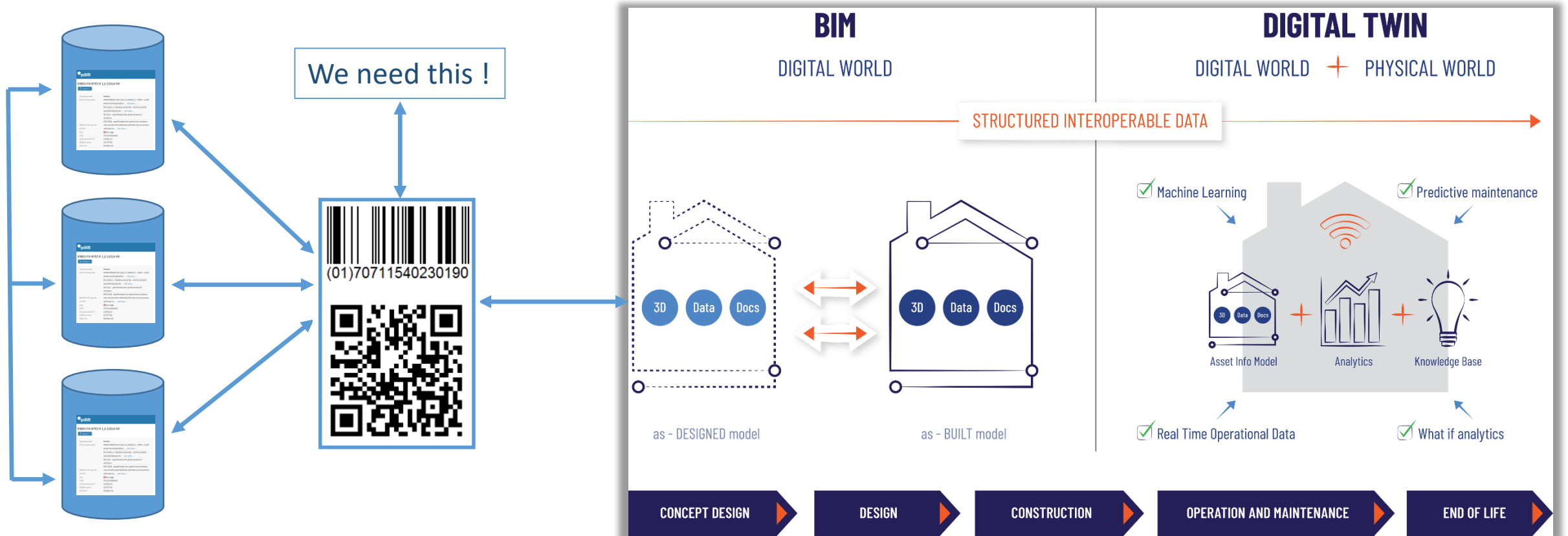

The as-designed model is based on input from the design teams which ultimately forms the basis for the as-built model that contains all the characteristics of a building. #CEN #ISO #ASTM etc. standards opens a closed market

BIM enables Cobuilder to provide data to create Digital Twins which is a virtual representation of physical as-built asset by linking standardized data to 3D. This opens a new digital market on planned development, where assets are sold

GS1 standards & structured Data Templates

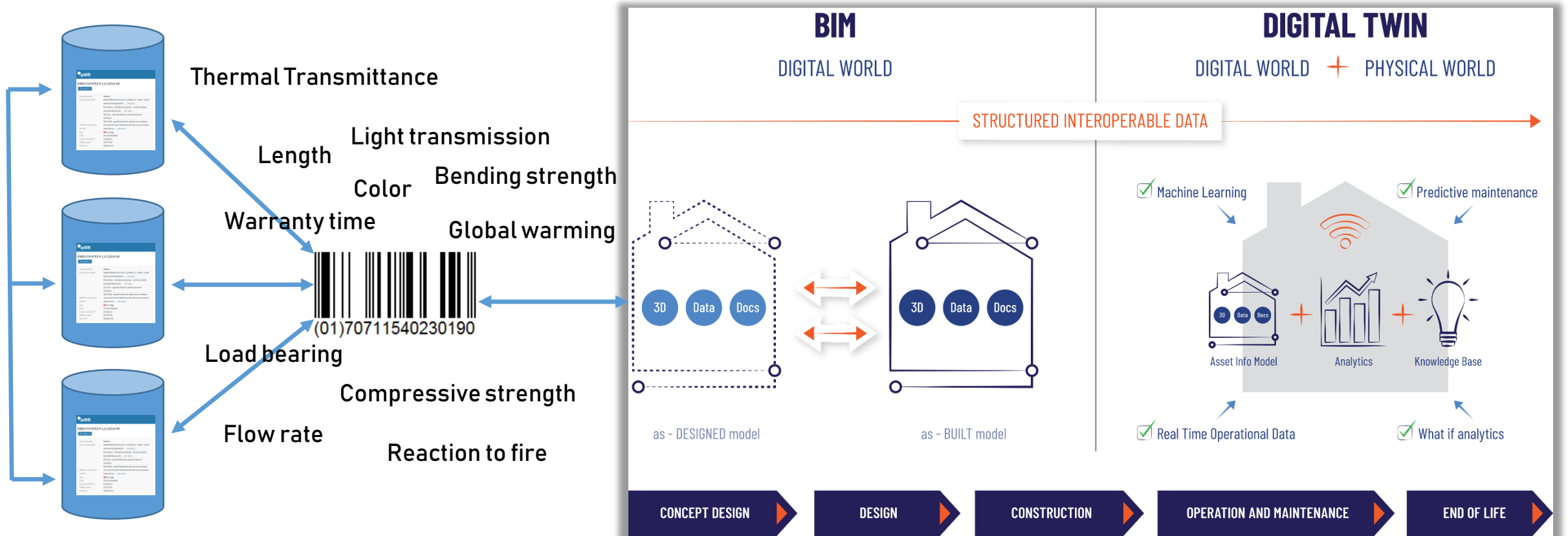

The as-designed model is based on input from the design teams which ultimately forms the basis for the as-built model that contains all the characteristics of a building. #CEN #ISO #ASTM etc. standards opens a closed market

BIM enables Cobuilder to provide data to create Digital Twins which is a virtual representation of physical as-built asset by linking standardized data to 3D. This opens a new digital market on planned development, where assets are sold

GS1 standards & structured DATA TEMPLATES

Request product information (seven attributes):

1. GTIN
2. Target Market
3. Brand
4. Company Name
5. Label Description
6. Medium Resolution Image
7. Global Product Classification

GS1

8. **Resistance to fire** according to EN 13501-2 (EI 15; EI 30; EI 45)
9. **Resistance to wind load** class according to EN 12211 (class 0; class 1)
10. **Burglar resistance** according to EN 356 (P1A; P2A; P3A)
11. **Frame width** according to EN 12519 (width of the frame in mm)
12. **Clear opening width** according to EN 12519 (fire escape width in mm)
13. **Colour** according to Natural Colour System (NCS 4055-R95B)
14. **Colour** according to RAL classic system (RAL 1005)
15. **Global warming potential** according to EN 15804 (kgCO₂ eq/piece)
16. **Warranty period** (number of months)

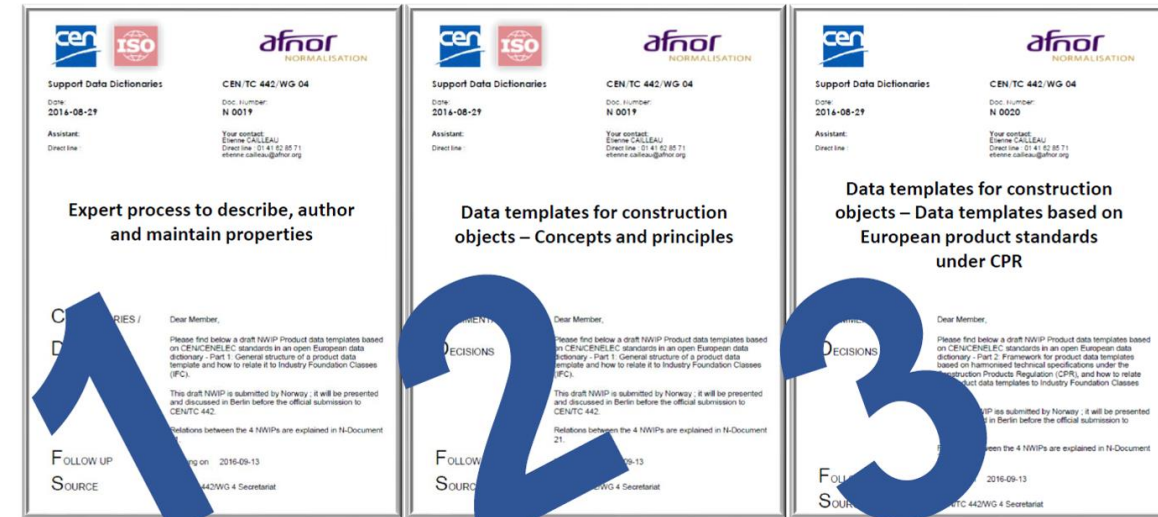

Data Template

Join the GS1 & BuildingSMART
workshop 12th of June 2019
in Oslo!

The use case – Clients Asset catalogue

FLOORS

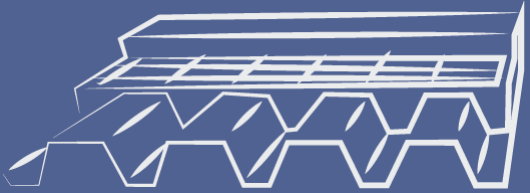

WALLS

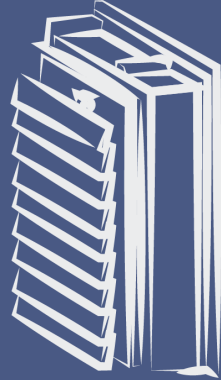

ROOFS

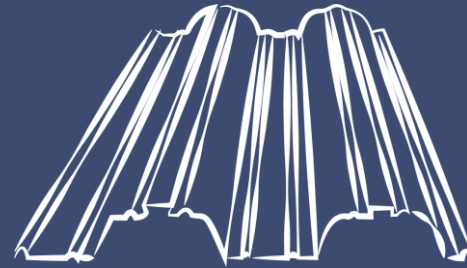

HVAC

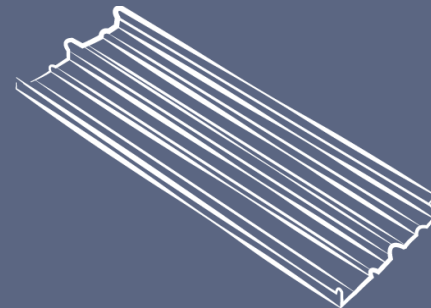
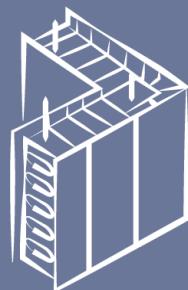
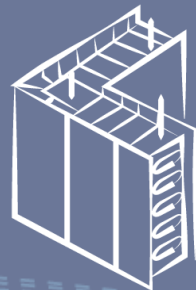
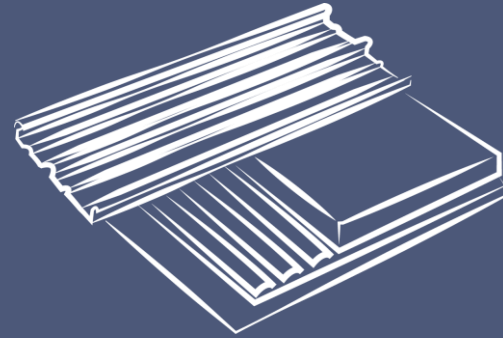
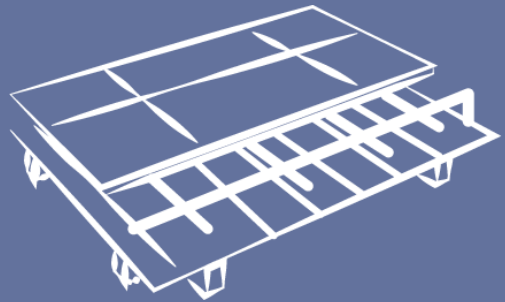
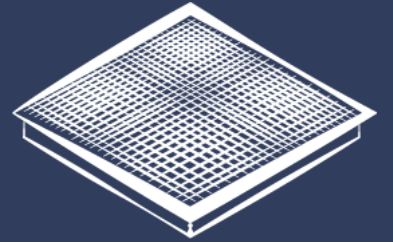

Creation of a Data Template for a wall

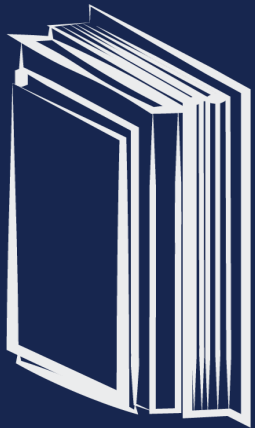

Name: External Wall

Description: Wall system to be used for external walls

System property name	According to	Value	Unit
Acoustic rating	undefined
Fire rating	undefined
Thermal transmittance	undefined



Name: *My External Wall*

Description: *Wall system with external insulation. $R_w = 45$ dB, EI60*

System property name	According to	Value	Unit
Acoustic rating	EN ISO 717-1	>43	dB
Fire rating	EN 13501-2	EI60	Unitless
Thermal transmittance	EN ISO 6946	<0.18	W/(m ² .K)

Setting requirements on component level in the Data Template



Component Name:
Stone Wool Insulation

MANUFACTURER DATA

PERFORMANCE DATA

ENVIRONMENTAL DATA

GEOMETRIC DATA

O&M DATA

Performance data

Property Name	According to	Value	Unit
Thermal Resistance	EN 12667	2.50	m ² K/W
Reaction to Fire	EN 13501-1	A1	unitless

+ Add custom property in performance data

Environmental data

Property Name	According to	Value	Unit
Global Warming Potential	EN 15804	1.2E+00	kgCO ₂
Declared Unit	EN 15804	1	eq. m ²

+ Add custom property in environmental data

Link Wall to model - Send spec to the supply chain



Name: My External Wall

Description: Wall system with external insulation.
Rw =45 dB, EI60

System property name	According to	Value	Unit
Acoustic rating	EN ISO 717-1	>43	dB
Fire rating	EN 13501-2	EI60	Unitless
Thermal transmittance	EN ISO 6946	<0.18	W/(m ² .K)

General purpose plastering mortar:	Product 1	Product 2	Product 3	Product 4
EPS:	Product 1	Product 2	Product 3	
Particleboard (1):	Product 1	Product 2	Product 3	Product 4
Structural timber:	Product 1	Product 2	Product 3	
Stone wool isolation:	Product 1	Product 2		
Particleboard (2):	Product 1	Product 2	Product 3	Product 4
Vapor barrier:	Product 1			
Gypsum plaster board:	Product 1	Product 2	Product 3	Product 4

Estimate Embodied Carbon Footprint from installed products



Embodied carbon coefficient of plaster board



Quantity of plaster board

Embodied carbon coefficient of stone wool



Quantity of stone wool

Embodied carbon coefficient of vapor barrier



Quantity of vapor barrier

Embodied carbon coefficient of timber section



Quantity of timber section

EMBODIED
CARBON
OF WALL

Gather Elemental Cost Data for Analysis

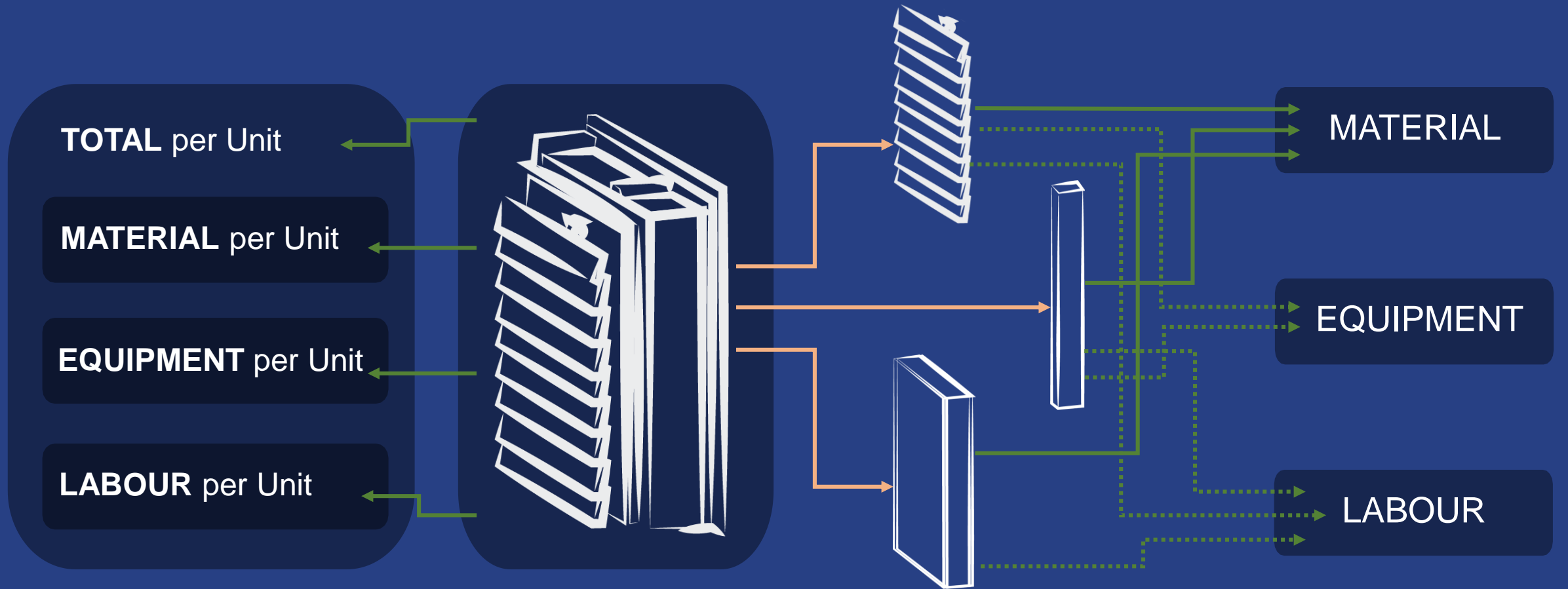

AUTHORING ENVIRONMENT

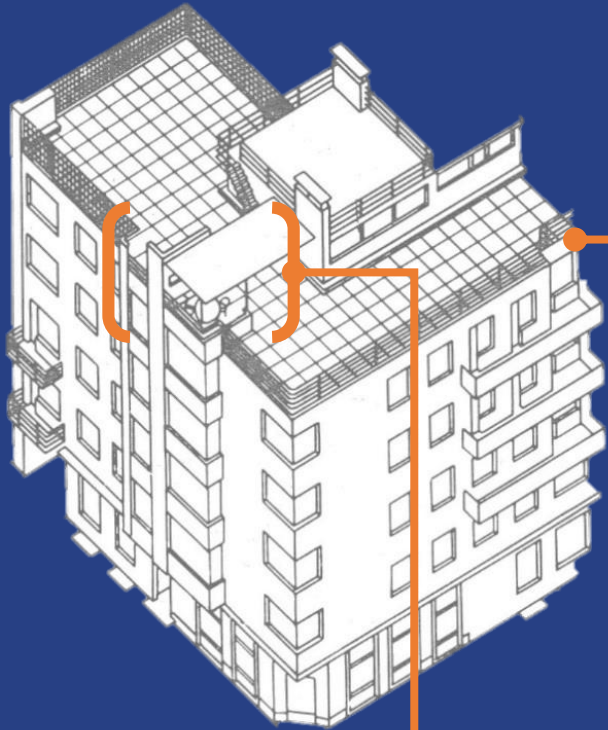

DIGITAL ASSET PLATFORM

LINK TO DIGITAL SPECIFICATION



BUILDING ELEMENT

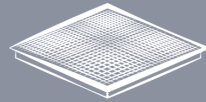

PRODUCT



BUILDING MODULE



EQUIPMENT

PUBLISH TAILORED SOLUTIONS

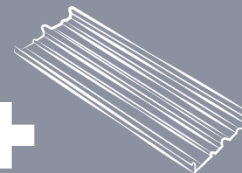

DIGITAL MARKETPLACES

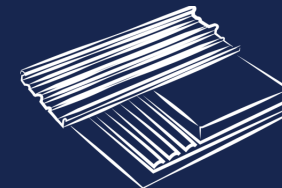
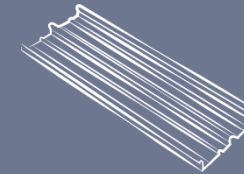
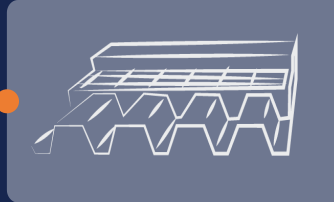



Please, contact us for further questions on **Data Templates** !

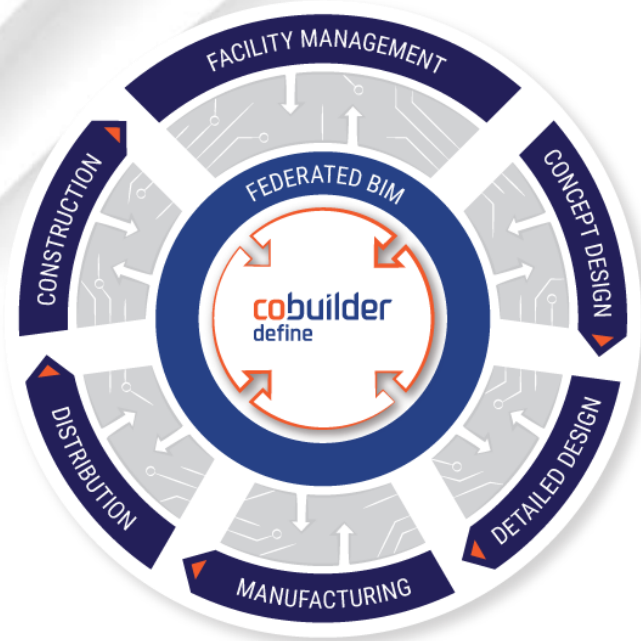

Thank you!

Lars Chr. Fredenlund
fredenlund@cobuilder.com

